

CS2671AX

Withstanding Voltage Tester



1. Leakage current and Test time can be continuously and freely set according to different standards.
2. Real time displays the test value actually reflects the DUT'S quality of withstanding voltage and insulation resistance.
3. Disqualification alerts with sound and light, cutting off voltage immediately at the same time.
4. Free set of leakage current warning which makes the warning value set be more convenient to different DUT for users.
5. Fast protection to the high voltage breakdown protects the DUT efficiently.
6. Remote control test gun is optional for flexible operation.
7. High test sensitivity and strong tape carrier capability. Normally works under low voltage and strong current state.
8. High precision assures the enough precision under high voltage and low current(Less than 0.5mA).
9. AC/DC Withstanding Voltage tester has strong expansibility and versatility (can be used in capacitor testing, voltage silicon stack testing, polarized power testing and testing of components etc.).

Guarantee

The instrument has been examined and checked by our company; its performance and specification have been tested completely and reached the standards before leaving factory.

The company guarantees the normal use of the instrument for one year from the instrument is sold out from the company or distributors. If it is the malfunction in circuit characteristics, the company provides maintenance for free except the following reasons; otherwise user shall afford the repairing fee:

- 1.Abnormal operations to the instrument without following the operating processes and orders;
- 2.Self modification or adjusting to the instrument.

Contents

I.safety rules.....	4
II.what will you notice before testing.....	6
III.Brief Introduction.....	7
IV.Working theory.....	8
V.Technical parameter.....	9
VI.PLC interface.....	33
VII.Operation Instructions and Procedures.....	34
IX.Calibration.....	42
X.Maintenance.....	46
XI.Packing List.....	46

I.safety rules

Note: please read the items of this chapter before testing the high voltage.

1.Common safe rules

- ① Before using it, please know about the safety signs of the withstanding voltage tester.
- ② Before switching on the power, please check to be sure whether the input voltage is right in comparison with the sign.

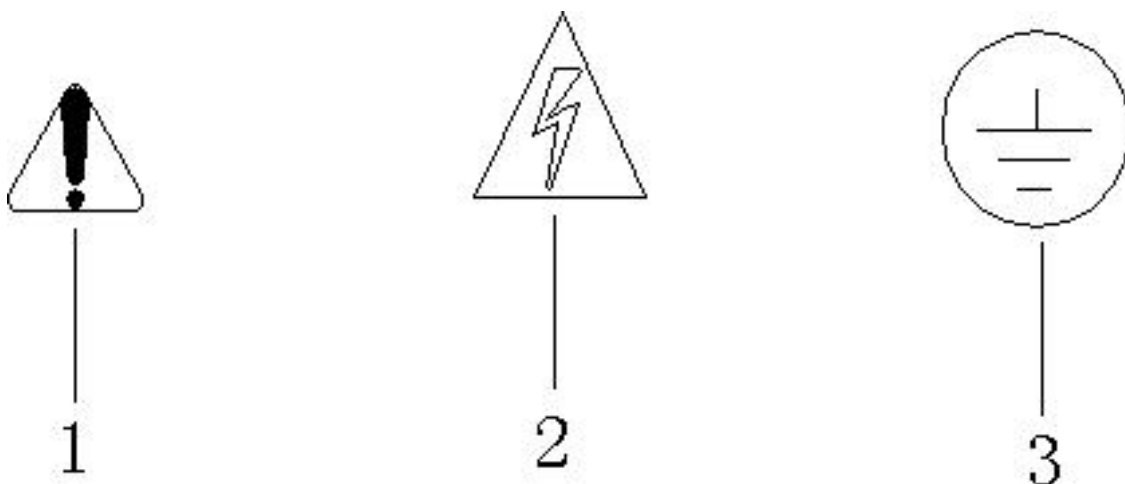

1---The warning sign of the high voltage. In order to avoiding the damage to the tester and injury to the user, please read the warnings and rules in the manual.

2---The danger sign. There may be the high voltage. Please do not touch it. 3---The ground sign.

The voltage and the current caused by the withstanding voltage tester are too high enough to hurt people. In order to avoiding the injury and the death, please first check it carefully when moving and using it.

2.Maintenance

(1)User's maintenance

In order to avoid an electric shock, please don't take apart the tester. The user mustn't repair all of the components in the tester. If the tester doesn't work well, please put in touch with CHANGSHENG Instrument CO., LTD or the appointe distributors.

(2)Periodic maintenance

According to the working frequency band, the input power cord, the P-wire, the correlative accessories and so on of the withstanding voltage tester need to be checked and examined carefully in period, which can protect the user and the accuracy of the tester.

(3)Modification of the user

The user mustn't modify the circuit and the components inside. If you did, the warrant of

the tester is invalid, and my company doesn't take the rap. The warrant is invalid either if you use the components and the accessories which are not accepted by CHANGSHENG Instrument CO., LTD. If the reprocessed product has already been modified, we will charge the maintenance costs and we will resume our design.

3.The working platform of testing

(1)Which situations are the best for the worktable?

It is important to select a suitable position for the worktable. So the place should be which the persons accept the operator far away from. If there is no place like that, you must isolate the worktable with the other instruments and mark it "Testing High Voltage Field". If the worktable is near other worktables, please mark "Danger! High voltage is being tested! Don't stay nearby!"

(2)The input power supply

A good ground is a vital part of the withstanding voltage tester. There is a ground interface in its back panel. Please check to be sure the ground connection has continuity. The tester must have the independent switch fixed in well-marked position, and the function of the switch must be marked. Once the emergency happened, cut off the power source at once, and then do with matter.

The input power of the tester is designed to be used on AC only. Its range is $220V \pm 10\%$. The frequency of the power is 50HZ. If the power in its range is instable, it maybe does harm to the components inside or cause the tester wrong running.

Note: The fuse in the tester must be a rapid melting model.

(3)The working test board

When tested, the tester must be placed on the worktable, which is the non-conductor. Don't use the conductor between the operator and the tested device. The position of the operator is appropriate. Don't stride the tested device to operate or adjust the tester. When operating the tester, the testing working field and around it don't contain fuel gas or the inflammable matter which can cause the explosion and fire hazard.

(4)Operator

The electric shock can cause the injury even death to the user when the wrong operation has been done. So it is important to train the suitable staff to use and operate the tester. The clothes of the operator mustn't contain the metal. And don't wear the metal, either such as the watch, i.e.. The persons who have the heart disease or carries the rate adjuster mustn't operate the tester.

(5)The essential point of safety

①The operator who is not fit for the job and the person who is incoherent with the job must far away from the test field.

②Keep the test field in order and in safety at any time.

③ Note: Don't touch the tested device or the devices, which are connected with it when testing.

④ Once any problems to the tester turned up, please cut off the high voltage output and input power.

⑤ After testing, please discharge first, and then remove the P-wire.

II.what will you notice before testing

The output of the withstanding voltage tester can output 20kV, the highest voltage. Any false operation will result in the misadventure even death. So please read this chapter carefully with the view of safety.

1.An electric shock

In order to avoiding the electric shock, please wear the rubber-insulated gloves before using the tester.

2.The tester is in the testing state

When the tester is running in the testing state, the P-wire, the tested device, the test probe and the output port all carry the high voltage. Please don't touch!

3.Changing the tested device

After finishing testing, when you change another tested device, please check to be sure:

① The tester is in the reset state.

② The test light is not flicking.

③ The figure of the voltage in the liquid-crystal display is not changing.

Especially notice: Don't touch the high voltage probe when changing the tested device.

4.Switch on or off the power switch

Once the power is cut off, please wait for a minute if you want to start it once more.

Caution: It is very dangerous in the high voltage output state to change the power state, "on" or "off", continuously. It also do harm to the tester.

Don't join the output port of the high voltage with any things when switching on or off the power for it maybe cause the abnormal high voltage output which is very hazard.

5.Emergency treatment

In order to avoiding the more loss, please do according to the following way under any emergent conditions such as an electric shock, the burning of the tested device or the host:

① First cut off the power.

② Then unplug the plug of the power.

6.Trouble occurring

The following situations are very dangerous. Be careful please! Because it may still output the high voltage even you press the "RESET".

①The test light is still going on when presses the "RESET" down.

②The voltmeter shows no readout while the test light is still going on.

When one of the situations occurs, please cut off the power and unplug its plug, and don't use it any more. The trouble is very dangerous. Please bring it to our company or the business-acted place to repair.

7.Trouble of the test light

The voltmeter shows the readout while the test light doesn't light after the "TEST" is pressed. This state may be the trouble of the test light. Please make the tester off and bring it to our company or the business-acted place to repair.

III.Brief Introduction

The withstand voltage tester is an instrument applied to measure the density of withstanding voltage. It can visually, accurately, quickly and reliably tests the breakdown voltage, leakage current and other electrical security performance indices of various measured objects, and can act as DC (AC) high voltage power supply to test the performance of components and the complete instrument. The CS267X series withstand voltage tester is designed according to the requirement of international and domestic security standards such as IEC, BS, UL, JIS and etc. Its withstanding voltage is range from 3kV to 20kV, and leakage current is 0 to 200 mA, which the special requirement is determined in addition. This instrument is suitable for all kinds of white goods, power supply, cables, transformers, connecting terminals, high-voltage Bakelite electrical appliances, switches, outlets and plugs, motors, dishwashers, washing machines, centrifugal driers, microwave ovens, electromagnetic machines, electronic ovens, electric firepot, electric rice cookers, TV sets, electric fanners, medical services, chemical engineering, electronic instruments, meters, complete machines and etc, and applied to provide the security withstand voltage protection for a strong electricity system and to test the leakage current. It is also an indispensable withstand voltage experiment device for scientific research laboratories and technical supervision departments.

The CS267X series products of withstand voltage testers, based on introducing and digesting the advanced withstand voltage testers worldwide, combine with a large number of practical usage cases from Chinese users to enhance and improve.

CS2670A, CS2670A-1, CS2670AX, CS2670Y, CS2671AX, CS2671BX, CS2671TX, CS2672BX, CS2672CX, CS2672DX, CS2673X,

CS2674AX type, etc withstand voltage testers are full digital model withstand voltage tester series products latterly developed by our factory. Both the testing voltage and the

leakage current dwell time are displayed in digital, which the technique is the first applied in China. Based on the original products, its performance is further improved. The leakage current can be continuously and optionally set from 0.1 mA to 100 mA according to the different security standards and the different requirements of users. For the time testing, the disadvantage, which the indication difference of the original product is a few greater, is improved, with the digital count-down-display, the precision of dwell time is increased to above $\pm 1\%$, and the testing range is improved to 99 s. Its

function is richer and more practical, and the actual leakage current values of the measured object can be reflected through the leakage current display to achieve which products its withstand voltage grade is better compared with the different lots of the similar products or different manufacturers' products, which the security performance of your products can be guaranteed to have no fault. At the same time, the digital displayed leakage current can be used to simultaneously display its function, and extended to measure the reverse voltage and reverse leakage current of the high voltage silicon rectifier stack, the reserve voltage and reserve leakage current of the high withstand voltage tube of a dynatron. It is a domestic leading withstand voltage tester compared from technique performance to quality, reliability.

IV.Working theory

Withstand Voltage tester is made up of high voltage rise circuit, leakage current detecting circuit and indicating meter. High voltage rise circuit can calibrate and output the required test voltage; Leakage current is capable of setting breakdown(protection) current; Indicating meter can directly read out the test voltage value and leakage current value(or set breakdown current value). DUT reaches the regulated time under the effect of test voltage, and instrument cuts off test voltage automatically or manually, once breakdown appears and leakage current goes beyond the set breakdown current, instrument can automatically cut off the output voltage and alert to confirm whether DUT can bear the insulation intensity test.

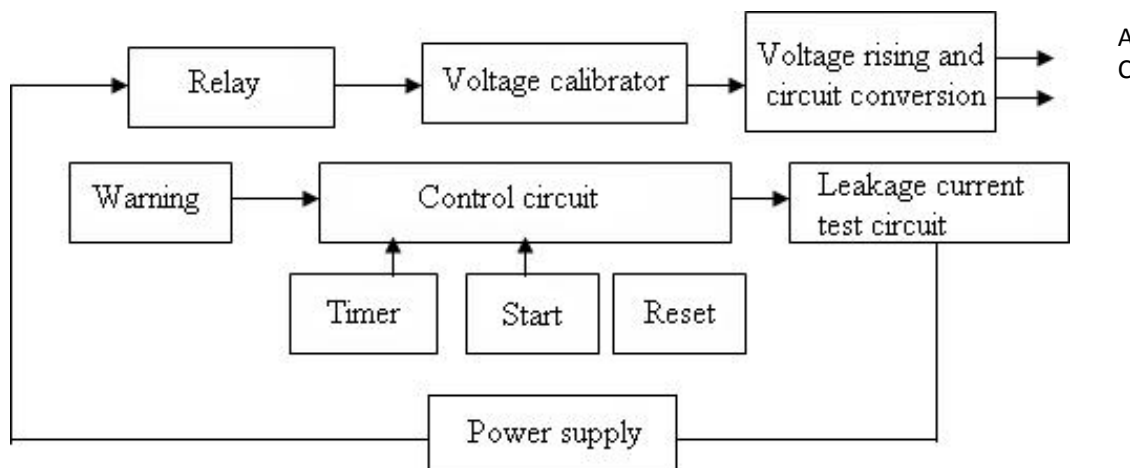

Standards:

IEC60065: Safety for audio, video and similar electronic apparatus IEC60204-1: Safety of machinery

IEC60335-1: Safety of household and similar electrical appliances IEC60598-1: Safety of lighting equipment

IEC60601-1: Safety of medical electrical equipment IEC60950: Safety of information technology equipment

IEC61010-1: Safety for electrical equipment for measurement, control and laboratory use

IEC61131-2: Safety for automatons

V. Technical parameter

1. Model List

MODEL	
CS2670A	ACW: 5kV, 20mA
CS2670A-1	ACW: 5kV, 20mA
CS2670AX	ACW: 5kV, 20mA
CS2670Y	ACW: 5kV, 20mA
CS2671AX	ACW: 10kV, 20mA; DCW: 10kV, 10mA
CS2671BX	ACW: 10kV, 50mA; DCW: 10kV, 20mA
CS2671TX	ACW: 10kV, 100mA
CS2672BX	ACW: 5kV, 100mA
CS2672CX	ACW: 5kV, 100mA DCW: 5kV, 20mA
CS2672DX	ACW: 5kV, 20mA DCW: 5kV, 10mA
CS2673X	ACW: 5kV, 200mA
CS2674AX	ACW: 20kV, 10mA; DCW: 20kV, 10mA

2. Technical parameters

①CS2670A/CS2670A-1/CS2670AX

MODEL		CS2670A	CS2670A-1	CS2670AX	CS2670 Y
ACW	Output voltage	(0.00~5.00) kV			
	Max. output power	100VA (5.000kV/20mA)			
	Max. current	20mA			
	Current range	2mA、20mA			
	Output waveform	sine wave			
	Waveform distortion	≤5% (unload or pure resistance load)			
	Test time	0.0s~999s 0=continue			

Volt meter	Range		0.00kV~5.00kV			
	Accuracy		± (5%+5 word)			
	resolution		10V			
	Displayed value		RMS			
Ammeter	Range	A C	0.100mA ~ 20.00mA			
	resolution	A C	2mA: 1uA, 20mA: 10uA			
	Accuracy		± (5%+5 words)			
Timer	Range		0.0s~999s			
	Min. resolution		0.1s			
	Accuracy		± (1%+50ms)			
PLC interface		no	no	yes	no	
Remote interface		yes				

②CS2671AX/CS2671BX/CS2671TX

MODEL		CS2671AX	CS2671BX	CS2671TX
AC W	Output voltage	(0.00~10.00) kV		
	Max.output power	100VA	500VA	1000VA
	Max. current	20mA	50mA	100mA
	Current range	2mA、20mA	2mA、20mA、50mA	2mA、20mA、100mA
	Output waveform	sine wave		
	Waveform distortion	≤5%		
	Test time	0.0s~999s 0.0= continue		
D CW	Output voltage	(0.00~10.00) kV		
	Max. output power	100VA	500VA	-----
	Max. current	10mA	20mA	-----
	Current range	2mA、10mA	2mA、20mA	-----
	Ripple factor	≤5%		
	Test time	0.0s~999s 0= continue		
Volt meter	Range	(0.00~10.00) kV		
	Accuracy	± (5%+5 words)		
	resolution	10V		
	Displayed value	RMS		

Ammeter	Measure Range	A	0.100mA ~	0.100mA ~	0.100 ~	
		C	20.00mA	50.00mA	100.0mA ~	
	Resolution	D	0.100mA ~	0.100mA ~	-----	
		C	10.00mA	20.00mA		
Accuracy	A	2mA: 1uA, 20mA: 10uA,50mA (100mA): 0.1mA				
		C	± (5%+5 words)			
Timer	Range	0.0s~999s				
	Min. resolution	0.1s				
	Accuracy	± (1%+50ms)				
PLC interface		no	no	Yes		
Remote interface		yes				

③CS2672BX/CS2672CX/CS2672DX

MODEL		CS2672BX	CS2672CX	CS2672DX
A C W	Output voltage	(0.00~5.00) kV		
	Maxoutput power	500VA		100VA
	Max. current	100mA		20mA
	Current range	2mA、20mA、100mA		2mA、20mA
	Output waveform	sine wave		
	Waveform distortion	≤5%		
	Test time	0.0s~999s	0.0= continue	
D C W	Output voltage	----- -----	(0.00~5.00) kV	(0.00~5.00) kV
	Max. output power	----- -----	100VA	50VA
	Max. current	----- -----	20mA	10mA
	Current range	----- -----	2mA、20mA	2mA、10mA
	Ripple factor	----- -----	≤5%	
	Test time	----- -----	0.0s~999s 0= continue	
Volt meter	Range	(0.00~50.00) kV		
	Accuracy	± (5%+5 words)		
	resolution	10V		
	Displayed value	RMS		

Ammeter	Measure Range	A C	0.100mA ~ 100.0mA	0.100mA ~ 100.0mA	0.100mA~ 20.00mA
		D C	----- ----	0.100mA ~ 20.00mA	0.100mA~ 10.00mA
	Resolution	2mA: 1uA, 20mA: 10uA, 50mA: 0.1mA			
	Accuracy	± (5%+5 words)			
Timer	Range	0.0s~999s			
	Min. resolution	0.1s			
	Accuracy	± (1%+50ms)			
PLC interface		no	no	Yes	
Remote interface		yes			

④CS2673X/CS2674AX

MODEL		CS2673X	CS2674AX	
A C W	Output voltage	(0.00~5.00) kV	(0.00~20.00) kV	
	Max. output power	500VA	200VA	
	Max. current	200mA	20mA	
	Current range	2mA、20mA、200mA	2mA、10mA	
	Output waveform	sine wave		
	Waveform distortion	≤5%		
	Test time	0.0s~999s	0.0= continue	
D C W	Output voltage	-----	(0.00~20.00) kV	
	Max. output power	-----	200VA	
	Max. current	-----	10mA	
	Current range	-----	2mA、10mA	
	Ripple factor	≤5%		
	Test time	0.0s~999s	0= continue	
Volt meter	Range	(0.00~5.00) kV	(0.00~20.00) kV	
	Accuracy	± (5%+5 words)		
	resolution	10V		
	Displayed value	RMS		
Ammeter	Measure Range	A C	0.100mA ~ 200.00mA	0.100mA ~ 10.00mA
		D C	----- --	0.100mA ~ 10.00mA
	Resolution	2mA: 1uA, 20mA: 10uA, 200mA: 0.1mA		

	Accuracy	$\pm (5\%+5 \text{ words})$		
Timer	Range	0.0s~999s		
	Min. resolution	0.1s		
	Accuracy	$\pm (1\%+50\text{ms})$		
PLC interface	no	no	Yes	
Remote interface	yes			

3.Front panel

①CS2670A/CS2670A-1/CS2670AX/CS2670Y front panel outline

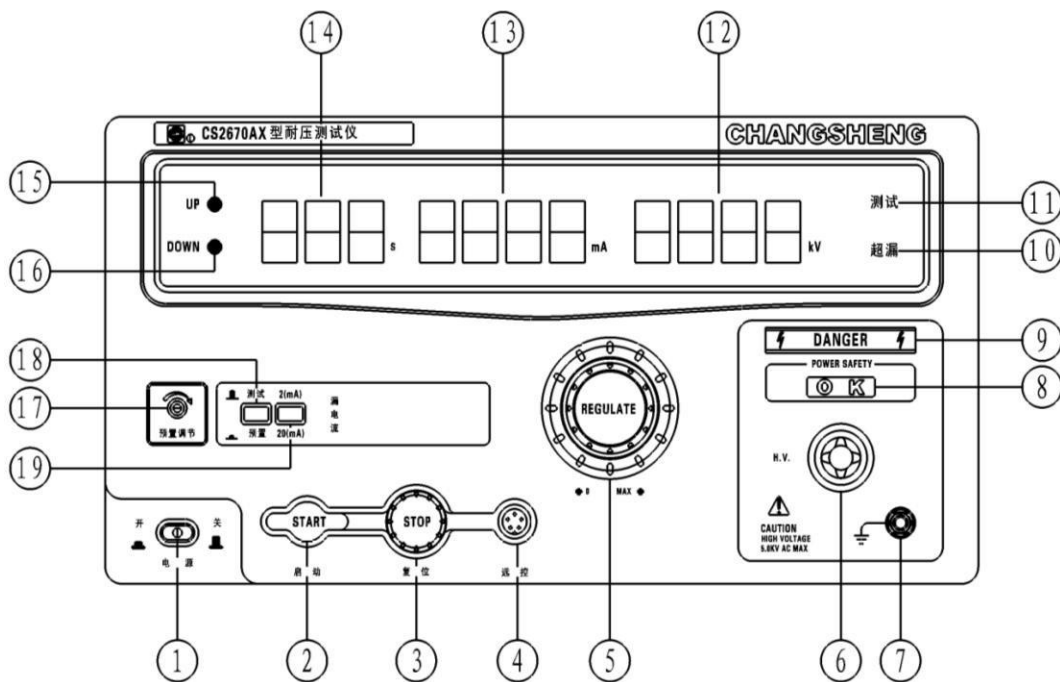

1、 Power switch

When the power switch is pressed, the tester is on, while pop-up it, the tester is off;

2、 START key

In the reset status, press this key, the tester starts to perform test

3、 STOP key

During the testing, it is used to interrupt the test. When DUT test failed, the failed indicator (10) is on, and at this time press the STOP key, the tester will stop alarming and enter into the next waiting test.

4、 Remote interface

Use the remote probe to start up or reset of test remotely.

5、 Voltage rotary knob

In the test of DUT, rotate this knob to regulate the output voltage (turn knob clockwise: voltage rising, while counterclockwise: voltage falling)

Confirm the rotary knob is at the position of "0" before power is on.

6、 High voltage output terminal (H.V.)

Press „test“ key, the terminal can generate high voltage. Do not touch the high voltage port, high voltage leads, high voltage probe and DUT.

7、 Loop terminal

It is the input terminal of measured current. During the test, the terminal leads should not be fallen off. If the test lead is fallen off, the DUT will be with high voltage and the electric shock maybe occurred.

8、 Power supply safety detecting indicator light “O K”

Plug in, judge whether N、L、G are properly connected or not. The power switch is off, if the

N、 L、 G is connected rightly, the “OK” indicator will light. If the N、 L、 G is wrongly connected, only “O” or “K” or neither of them is lighted. Please check the power supply. When power on, the indicator lights out.

9、 High voltage output indication

The indicator is not controlled by the main circuit. If the output voltage is more than 50V, the indicator will light up. If it is lighted on the reset status, the H.V. terminal maybe existed high voltage, please do not touch any part of the circuit. When the tester outputs high voltage, the indicator lights up all the time, which indicates it is dangerous during high voltage outputting.

10、 Fail indicator

When the test is failed, the indicator will light.

11、 Test indicator

When the start key is pressed, the indicator will light.

12、 Voltage display

13、 Current display

14、 Time display

Time is range from 0.0s to 999s. When the test time is less than 100s, the resolution is 0.1s; while the time is greater than or equal to 100s, the resolution is 1s. If the time is set to 0.0s, the test time will add counts; when the time is not set to 0, the time will be down counting.

15、 UP key

When do the test time set, press the up key, the test time set will be up.

16、 DOWN key

When do the test time set, press the down key, the test time set will be down.

17、 Current preset adjustment potentiometer

After pressing the numbered (18) button "test / Pre-set", the tester will enter into the current preset state, the current display will show the preset current value, clockwise to increase the preset current; counterclockwise to decrease the preset current.

18、Test /pre-set key

This key is pressed for the pre-set current state, while pop-up for test status.

19、2mA/20mA switch gear

Press the key is for 20mA gear, pop-up for 2mA gear.

②CS2671AX front panel outline

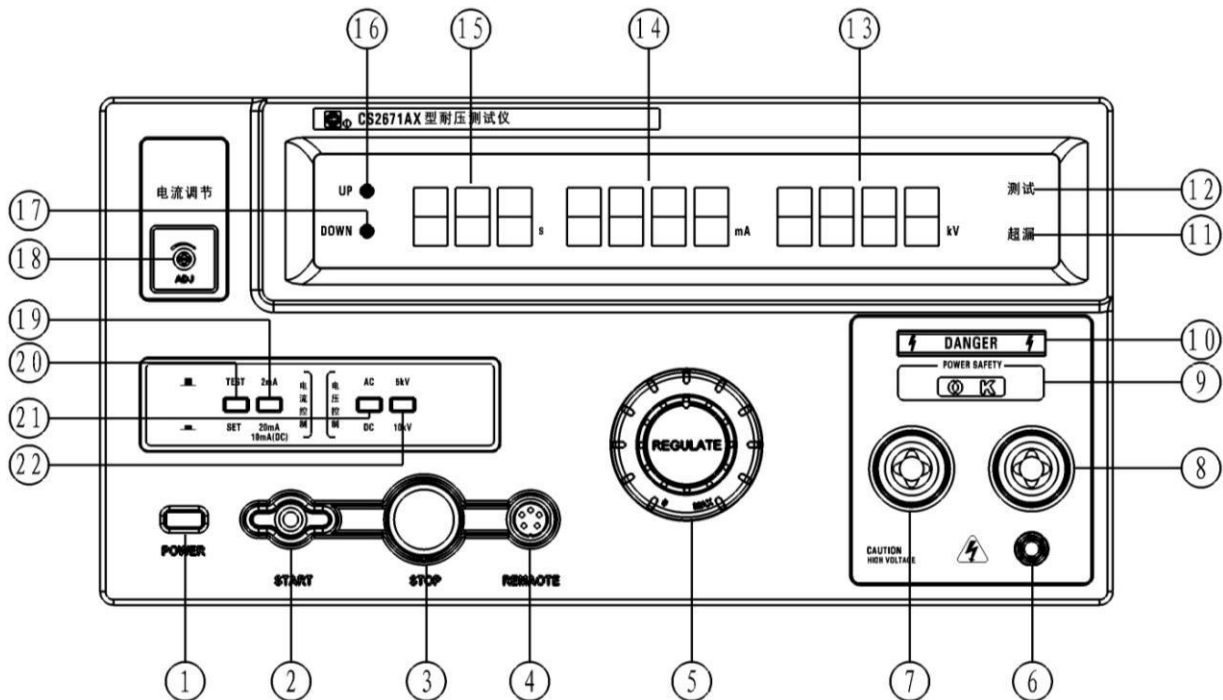

1、Power switch

When the power switch is pressed, the tester is on, while pop-up it, the tester is off;

2、START key

In the reset status, press this key, the tester starts to perform test

3、STOP key

During the testing, it is used to interrupt the test. When DUT test failed, the failed indicator (10) is on, and at this time press the STOP key, the tester will stop alarming and enter into the next waiting test.

4、Remote interface

Use the remote probe to start up or reset of test remotely.

5、Voltage rotary knob

In the test of DUT, rotate this knob to regulate the output voltage (turn knob clockwise: voltage rising, while counterclockwise: voltage falling)

Confirm the rotary knob is at the position of "0" before power is on.

6、Loop terminal

It is the input terminal of measured current. During the test, the terminal leads should not be fallen off. If the test lead is fallen off, the DUT will be with high voltage and the electric

shock maybe occurred.

7、 DC High voltage output terminal (H.V.)

Press „test“ key, the terminal can generate DC high voltage. Do not touch the high voltage port, high voltage leads, high voltage probe and DUT. After the test is finished, make sure that all the electricity on the entire circuit has been discharged before change another DUT.

8、 AC High voltage output terminal (H.V.)

Press „test“ key, the terminal can generate AC high voltage. Do not touch the high voltage port, high voltage leads, high voltage probe and DUT.

9、 Power supply safety detecting indicator light “O K”

Plug in, judge whether N、L、G are properly connected or not. The power switch is off, if the

N、 L、 G is connected rightly, the “OK” indicator will light. If the N、 L、 G is wrongly connected, only “O” or “K” or neither of them is lighted. Please check the power supply.

When power on, the indicator lights out.

10、 High voltage output indication

The indicator is not controlled by the main circuit. If the output voltage is more than 50V, the indicator will light up. If it is lighted on the reset status, the H.V. terminal maybe existed high voltage, please do not touch any part of the circuit. When the tester outputs high voltage, the indicator lights up all the time, which indicates it is dangerous during high voltage outputting.

11、 Fail indicator

When the test is failed, the indicator will light.

12、 Test indicator

When the start key is pressed, the indicator will light.

13、 Voltage display 14、 Current display

15、 Time display

Time is range from 0.0s to 999s. When the test time is less than 100s, the resolution is 0.1s; while the time is greater than or equal to 100s, the resolution is 1s. If the time is set to 0.0s, the test time will add counts; when the time is not set to 0, the time will be down counting.

16、 UP key

When do the test time set, press the up key, the test time set will be up.

17、 DOWN key

When do the test time set, press the down key, the test time set will be down.

18、 Current preset adjustment potentiometer

After pressing the numbered (18) button "test / Pre-set", the tester will enter into the

current preset state, the current display will show the preset current value, clockwise to increase the preset current; counterclockwise to decrease the preset current.

19、2mA/20mA switch gear

Press the key is for 20mA gear, pop-up for 2mA gear.

20、Test /pre-set key

This key is pressed for the pre-set current state, while pop-up for test status.

21、Test /pre-set key

Press the key is for DCW test, pop-up for ACW test.

22、Test /pre-set key

Press the key is for 10kV gear, pop-up for 5kV gear.

④CS2671BX front panel outline

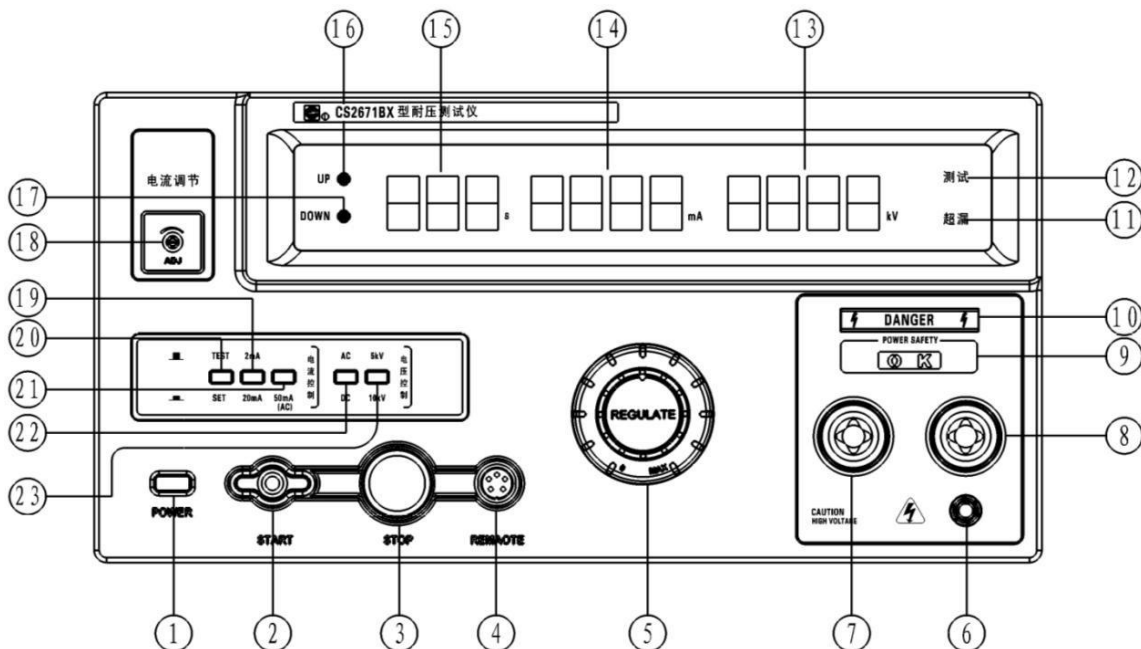

1、Power switch

When the power switch is pressed, the tester is on, while pop-up it, the tester is off;

2、START key

In the reset status, press this key, the tester starts to perform test

3、STOP key

During the testing, it is used to interrupt the test. When DUT test failed, the failed indicator (10) is on, and at this time press the STOP key, the tester will stop alarming and enter into the next waiting test.

4、Remote interface

Use the remote probe to start up or reset of test remotely.

5、Voltage rotary knob

In the test of DUT, rotate this knob to regulate the output voltage (turn knob clockwise:

voltage rising, while counterclockwise: voltage falling)

Confirm the rotary knob is at the position of "0" before power is on.

6、 Loop terminal

It is the input terminal of measured current. During the test, the terminal leads should not be fallen off. If the test lead is fallen off, the DUT will be with high voltage and the electric shock maybe occurred.

7、 DC High voltage output terminal (H.V.)

Press „test“ key, the terminal can generate DC high voltage. Do not touch the high voltage port, high voltage leads, high voltage probe and DUT. After the test is finished, make sure that all the electricity on the entire circuit has been discharged before change another DUT.

8、 AC High voltage output terminal (H.V.)

Press „test“ key, the terminal can generate AC high voltage. Do not touch the high voltage port, high voltage leads, high voltage probe and DUT.

9、 Power supply safety detecting indicator light “O K”

Plug in, judge whether N、 L、 G are properly connected or not. The power switch is off, if the N、 L、 G is connected rightly, the “OK” indicator will light. If the N、 L、 G is wrongly connected, only “O” or “K” or neither of them is lighted. Please check the power supply. When power on, the indicator lights out.

10、 High voltage output indication

The indicator is not controlled by the main circuit. If the output voltage is more than 50V, the indicator will light up. If it is lighted on the reset status, the H.V. terminal maybe existed high voltage, please do not touch any part of the circuit. When the tester outputs high voltage, the indicator lights up all the time, which indicates it is dangerous during high voltage outputting.

11、 Fail indicator

When the test is failed, the indicator will light.

12、 Test indicator

When the start key is pressed, the indicator will light.

13、 Voltage display 14、 Current display

15、 Time display

Time is range from 0.0s to 999s. When the test time is less than 100s, the resolution is 0.1s; while the time is greater than or equal to 100s, the resolution is 1s. If the time is set to 0.0s, the test time will add counts; when the time is not set to 0, the time will be down counting.

16、 UP key

When do the test time set, press the up key, the test time set will be up.

17、DOWN key

When do the test time set, press the down key, the test time set will be down.

18、Current preset adjustment potentiometer

After pressing the numbered (18) button "test / Pre-set", the tester will enter into the current preset state, the current display will show the preset current value, clockwise to increase the preset current; counterclockwise to decrease the preset current.

19、2mA/20mA switch gear

Press the key is for 20mA gear, pop-up for 2mA gear.

20、Test /pre-set key

This key is pressed for the pre-set current state, while pop-up for test status.

21、50mA gear key

Press the key is for 50mA gear, pop-up for 2mA/20mA gear

22、AC/DC switch key

Press the key is for DCW test, pop-up for ACW test.

23、5kV/10kV switch key

Press the key is for 10kV gear, pop-up for 5kV gear.

⑤CS2672BX front panel outline

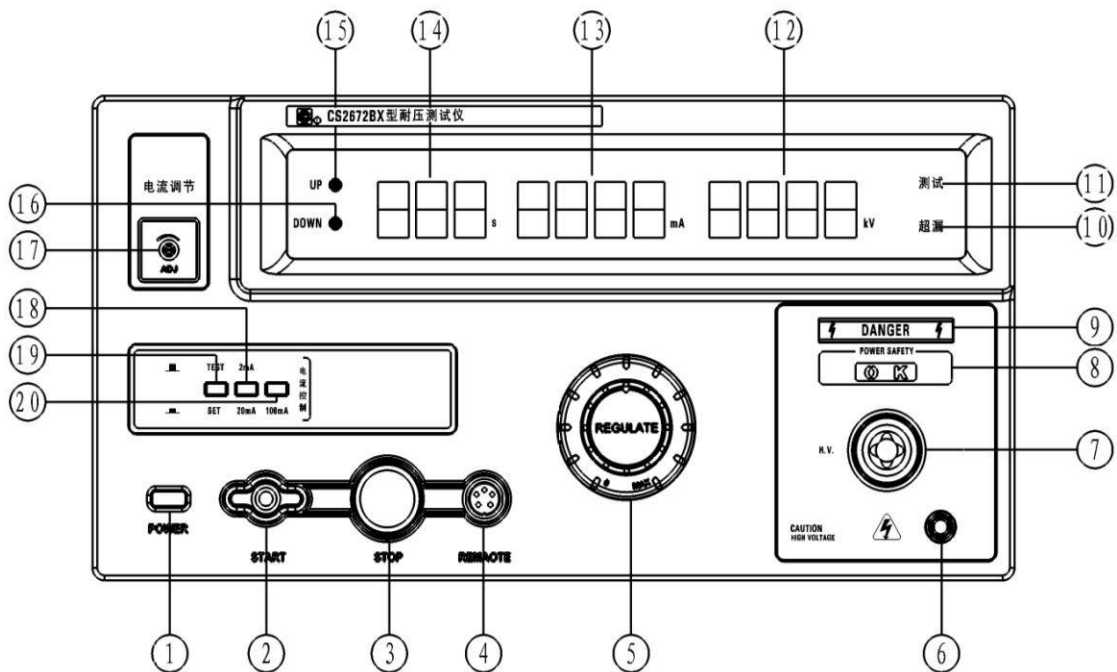

1、Power switch

When the power switch is pressed, the tester is on, while pop-up it, the tester is off;

2、START key

In the reset status, press this key, the tester starts to perform test

3、STOP key

During the testing, it is used to interrupt the test. When DUT test failed, the failed indicator (10) is on, and at this time press the STOP key, the tester will stop alarming and enter into the next waiting test.

4、Remote interface

Use the remote probe to start up or reset of test remotely.

5、Voltage rotary knob

In the test of DUT, rotate this knob to regulate the output voltage (turn knob clockwise: voltage rising, while counterclockwise: voltage falling)

Confirm the rotary knob is at the position of "0" before power is on.

6、Loop terminal

It is the input terminal of measured current. During the test, the terminal leads should not be fallen off. If the test lead is fallen off, the DUT will be with high voltage and the electric shock maybe occurred.

7、High voltage output terminal (H.V.)

Press „test“ key, the terminal can generate high voltage. Do not touch the high voltage port, high voltage leads, high voltage probe and DUT.

8、Power supply safety detecting indicator light “O K”

Plug in, judge whether N、L、G are properly connected or not. The power switch is off, if the

N、L、G is connected rightly, the “OK” indicator will light. If the N、L、G is wrongly connected, only “O” or “K” or neither of them is lighted. Please check the power supply.

When power on, the indicator lights out.

9、High voltage output indicator

The indicator is not controlled by the main circuit. If the output voltage is more than 50V, the indicator will light up. If it is lighted on the reset status, the H.V. terminal maybe existed high voltage, please do not touch any part of the circuit. When the tester outputs high voltage, the indicator lights up all the time, which indicates it is dangerous during high voltage outputting.

10、Fail indicator

When the test is failed, the indicator will light.

11、Test indicator

When the start key is pressed, the indicator will light.

12、Voltage display 13、Current display 14、Time display

Time is range from 0.0s to 999s. When the test time is less than 100s, the resolution is 0.1s; while the time is greater than or equal to 100s, the resolution is 1s. If the time is set to 0.0s, the test time will add counts; when the time is not set to 0, the time will be down

counting.

15、UP key

When do the test time set, press the up key, the test time set will be up.

16、DOWN key

When do the test time set, press the down key, the test time set will be down.

17、Current preset adjustment potentiometer

After pressing the numbered (18) button "test / Pre-set", the tester will enter into the current preset state, the current display will show the preset current value, clockwise to increase the preset current; counterclockwise to decrease the preset current.

18、Test /pre-set key

This key is pressed for the pre-set current state, while pop-up for test status.

19、2mA/20mA switch gear

Press the key is for 20mA gear, pop-up for 2mA gear.

20、100mA switch gear

Press the key is for 100mA gear, pop-up for 2mA/20mA gear.

⑥CS2672CX front panel outline

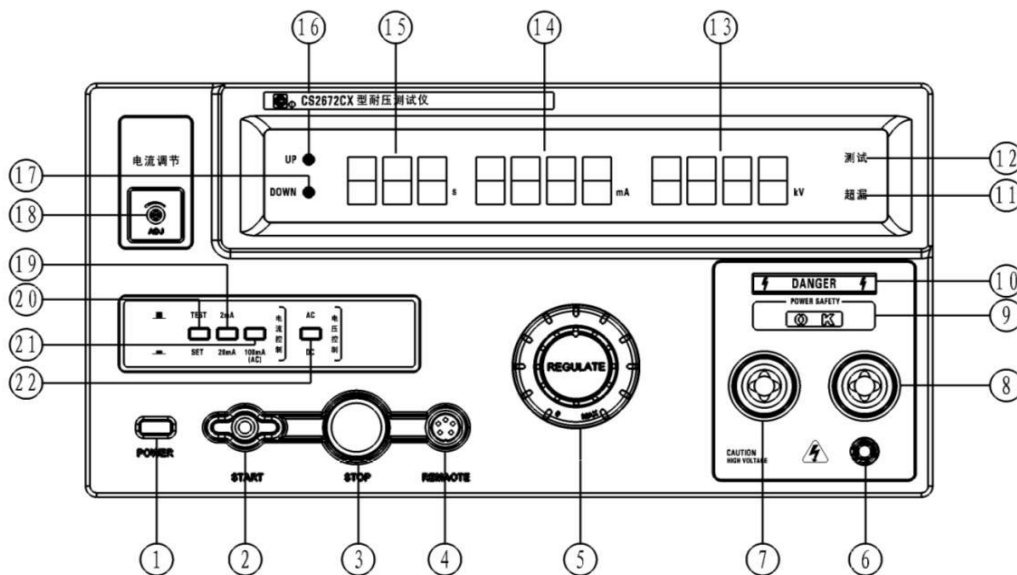

1、Power switch

When the power switch is pressed, the tester is on, while pop-up it, the tester is off;

2、START key

In the reset status, press this key, the tester starts to perform test

3、STOP key

During the testing, it is used to interrupt the test. When DUT test failed, the failed indicator (10) is on, and at this time press the STOP key, the tester will stop alarming and enter into the next waiting test.

4、 Remote interface

Use the remote probe to start up or reset of test remotely.

5、 Voltage rotary knob

In the test of DUT, rotate this knob to regulate the output voltage (turn knob clockwise: voltage rising, while counterclockwise: voltage falling)

Confirm the rotary knob is at the position of "0" before power is on.

6、 Loop terminal

It is the input terminal of measured current. During the test, the terminal leads should not be fallen off. If the test lead is fallen off, the DUT will be with high voltage and the electric shock maybe occurred.

7、 DC High voltage output terminal (H.V.)

Press „test“ key, the terminal can generate DC high voltage. Do not touch the high voltage port, high voltage leads, high voltage probe and DUT. After the test is finished, make sure that all the electricity on the entire circuit has been discharged before change another DUT.

8、 AC High voltage output terminal (H.V.)

Press „test“ key, the terminal can generate AC high voltage. Do not touch the high voltage port, high voltage leads, high voltage probe and DUT.

9、 Power supply safety detecting indicator light “O K”

Plug in, judge whether N、 L、 G are properly connected or not. The power switch is off, if the N、 L、 G is connected rightly, the “OK” indicator will light. If the N、 L、 G is wrongly connected, only “O” or “K” or neither of them is lighted. Please check the power supply. When power on, the indicator lights out.

10、 High voltage output indication

The indicator is not controlled by the main circuit. If the output voltage is more than 50V, the indicator will light up. If it is lighted on the reset status, the H.V. terminal maybe existed high voltage, please do not touch any part of the circuit. When the tester outputs high voltage, the indicator lights up all the time, which indicates it is dangerous during high voltage outputting.

11、 Fail indicator

When the test is failed, the indicator will light.

12、 Test indicator

When the start key is pressed, the indicator will light.

13、 Voltage display 14、 Current display

15、 Time display

Time is range from 0.0s to 999s. When the test time is less than 100s, the resolution is

0.1s; while the time is greater than or equal to 100s, the resolution is 1s. If the time is set to 0.0s, the test time will add counts; when the time is not set to 0, the time will be down counting.

16、UP key

When do the test time set, press the up key, the test time set will be up.

17、DOWN key

When do the test time set, press the down key, the test time set will be down.

18、Current preset adjustment potentiometer

After pressing the numbered (18) button "test / Pre-set", the tester will enter into the current preset state, the current display will show the preset current value, clockwise to increase the preset current; counterclockwise to decrease the preset current.

19、2mA/20mA switch gear

Press the key is for 20mA gear, pop-up for 2mA gear.

20、Test /pre-set key

This key is pressed for the pre-set current state, while pop-up for test status.

21、100mA gear key

Press the key is for 100mA gear, pop-up for 2mA/20mA gear

22、AC/DC switch key

Press the key is for DCW test, pop-up for ACW test.

⑦CS2672DX front panel outline

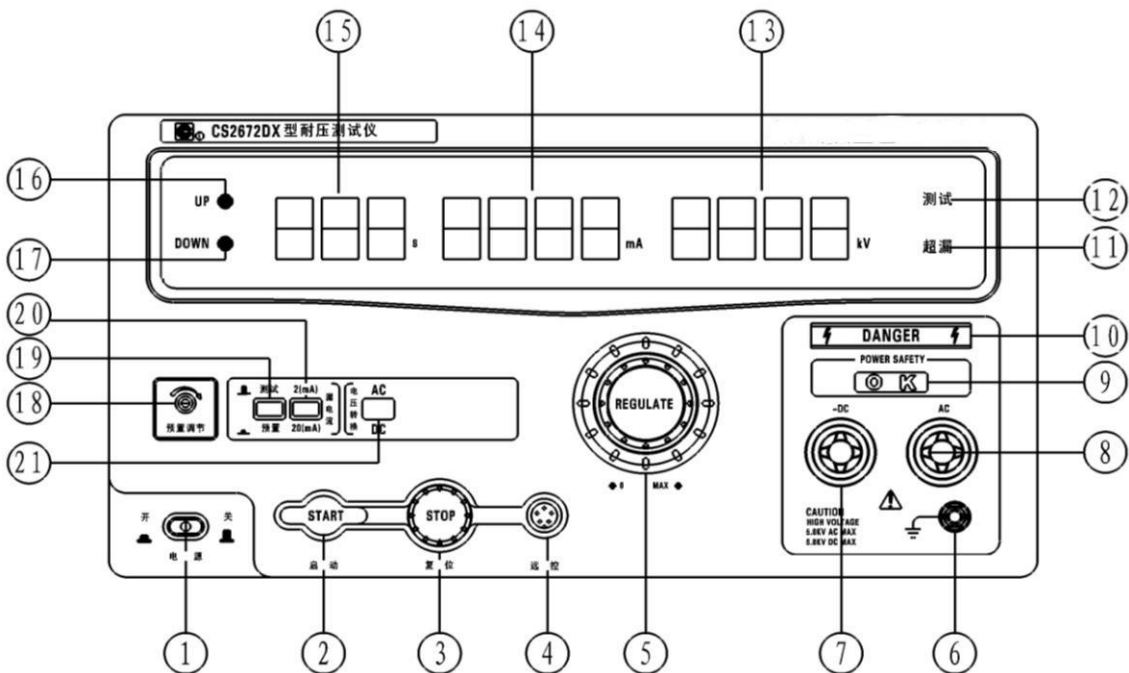

1、Power switch

When the power switch is pressed, the tester is on, while pop-up it, the tester is off;

2、 START key

In the reset status, press this key, the tester starts to perform test

3、 STOP key

During the testing, it is used to interrupt the test. When DUT test failed, the failed indicator (10) is on, and at this time press the STOP key, the tester will stop alarming and enter into the next waiting test.

4、 Remote interface

Use the remote probe to start up or reset of test remotely.

5、 Voltage rotary knob

In the test of DUT, rotate this knob to regulate the output voltage (turn knob clockwise: voltage rising, while counterclockwise: voltage falling)

Confirm the rotary knob is at the position of "0" before power is on.

6、 Loop terminal

It is the input terminal of measured current. During the test, the terminal leads should not be fallen off. If the test lead is fallen off, the DUT will be with high voltage and the electric shock maybe occurred.

7、 DC High voltage output terminal (H.V.)

Press „test“ key, the terminal can generate DC high voltage. Do not touch the high voltage port, high voltage leads, high voltage probe and DUT. After the test is finished, make sure that all the electricity on the entire circuit has been discharged before change another DUT.

8、 AC High voltage output terminal (H.V.)

Press „test“ key, the terminal can generate AC high voltage. Do not touch the high voltage port, high voltage leads, high voltage probe and DUT.

9、 Power supply safety detecting indicator light “O K”

Plug in, judge whether N、L、G are properly connected or not. The power switch is off, if the

N、 L、 G is connected rightly, the “OK” indicator will light. If the N、 L、 G is wrongly connected, only “O” or “K” or neither of them is lighted. Please check the power supply.

When power on, the indicator lights out.

10、 High voltage output indication

The indicator is not controlled by the main circuit. If the output voltage is more than 50V, the indicator will light up. If it is lighted on the reset status, the H.V. terminal maybe existed high voltage, please do not touch any part of the circuit. When the tester outputs high voltage, the indicator lights up all the time, which indicates it is dangerous during high voltage outputting.

11、 Fail indicator

When the test is failed, the indicator will light.

12、 Test indicator

When the start key is pressed, the indicator will light.

13、 Voltage display

14、 14、 Current display

15、 Time display

Time is range from 0.0s to 999s. When the test time is less than 100s, the resolution is 0.1s; while the time is greater than or equal to 100s, the resolution is 1s. If the time is set to 0.0s, the test time will add counts; when the time is not set to 0, the time will be down counting.

16、 UP key

When do the test time set, press the up key, the test time set will be up.

17、 DOWN key

When do the test time set, press the down key, the test time set will be down.

18、 Current preset adjustment potentiometer

After pressing the numbered (18) button "test / Pre-set", the tester will enter into the current preset state, the current display will show the preset current value, clockwise to increase the preset current; counterclockwise to decrease the preset current.

19、 Test /pre-set key

This key is pressed for the pre-set current state, while pop-up for test status.

20、 2mA/20mA switch gear

Press the key is for 20mA gear, pop-up for 2mA gear.

22、 AC/DC switch key

Press the key is for DCW test, pop-up for ACW test.

⑧CS2673X front panel outline

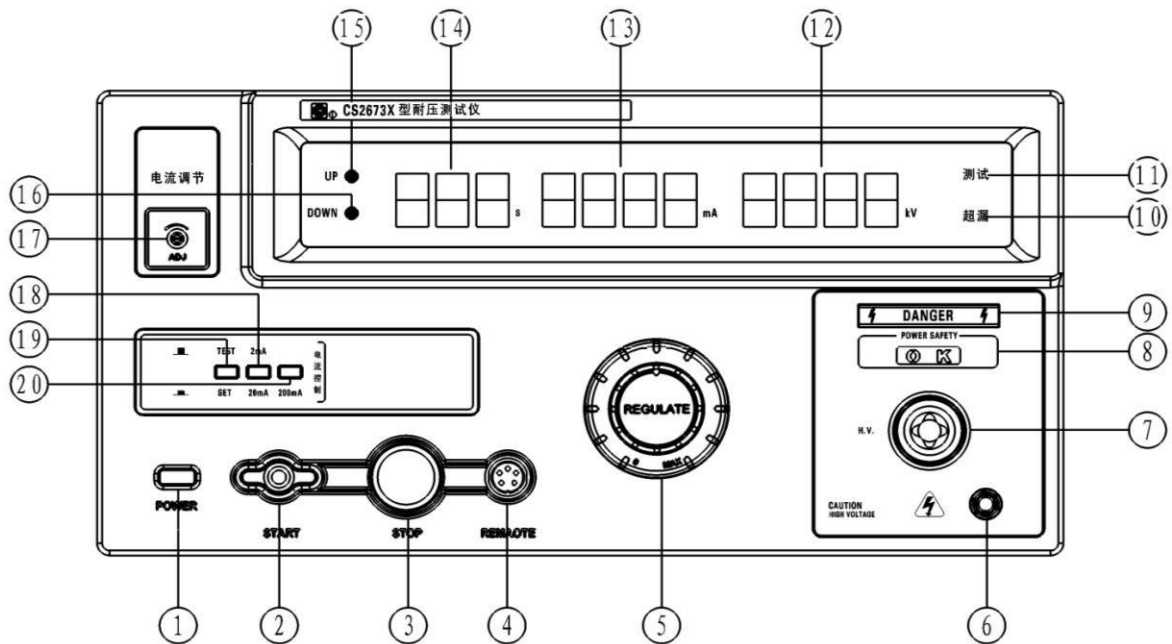

1、 Power switch

When the power switch is pressed, the tester is on, while pop-up it, the tester is off;

2、 START key

In the reset status, press this key, the tester starts to perform test

3、 STOP key

During the testing, it is used to interrupt the test. When DUT test failed, the failed indicator (10) is on, and at this time press the STOP key, the tester will stop alarming and enter into the next waiting test.

4、 Remote interface

Use the remote probe to start up or reset of test remotely.

5、 Voltage rotary knob

In the test of DUT, rotate this knob to regulate the output voltage (turn knob clockwise: voltage rising, while counterclockwise: voltage falling)

Confirm the rotary knob is at the position of "0" before power is on.

6、 Loop terminal

It is the input terminal of measured current. During the test, the terminal leads should not be fallen off. If the test lead is fallen off, the DUT will be with high voltage and the electric shock maybe occurred.

7、 High voltage output terminal (H.V.)

Press „test“ key, the terminal can generate high voltage. Do not touch the high voltage port, high voltage leads, high voltage probe and DUT.

8、 Power supply safety detecting indicator light "OK"

Plug in, judge whether N、 L、 G are properly connected or not. The power switch is off, if

the N、L、G is connected rightly, the “OK” indicator will light. If the N、L、G is wrongly connected, only “O” or “K” or neither of them is lighted. Please check the power supply. When power on, the indicator lights out.

9、High voltage output indicator

The indicator is not controlled by the main circuit. If the output voltage is more than 50V, the indicator will light up. If it is lighted on the reset status, the H.V. terminal maybe existed high voltage, please do not touch any part of the circuit. When the tester outputs high voltage, the indicator lights up all the time, which indicates it is dangerous during high voltage outputting.

10、Fail indicator

When the test is failed, the indicator will light.

11、Test indicator

When the start key is pressed, the indicator will light.

12、Voltage display

13、Current display 14、Time display

Time is range from 0.0s to 999s. When the test time is less than 100s, the resolution is 0.1s; while the time is greater than or equal to 100s, the resolution is 1s. If the time is set to 0.0s, the test time will add counts; when the time is not set to 0, the time will be down counting.

15、UP key

When do the test time set, press the up key, the test time set will be up.

16、DOWN key

When do the test time set, press the down key, the test time set will be down.

17、Current preset adjustment potentiometer

After pressing the numbered (18) button "test / Pre-set", the tester will enter into the current preset state, the current display will show the preset current value, clockwise to increase the preset current; counterclockwise to decrease the preset current.

18、2mA/20mA switch gear

Press the key is for 20mA gear, pop-up for 2mA gear.

19、Test /pre-set key

This key is pressed for the pre-set current state, while pop-up for test status.

20、200mA switch gear

Press the key is for 200mA gear, pop-up for 2mA/20mA gear.

⑨CS2671TX front panel outline

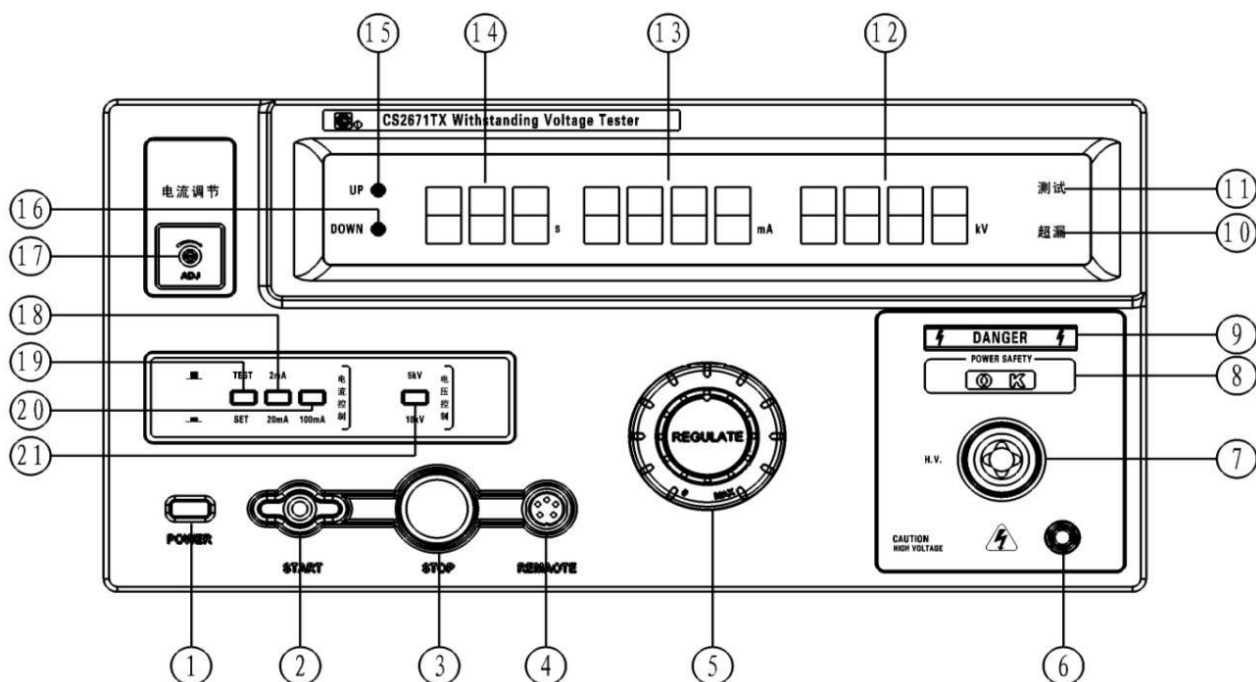

1、Power switch

When the power switch is pressed, the tester is on, while pop-up it, the tester is off;

2、START key

In the reset status, press this key, the tester starts to perform test

3、STOP key

During the testing, it is used to interrupt the test. When DUT test failed, the failed indicator (10) is on, and at this time press the STOP key, the tester will stop alarming and enter into the next waiting test.

4、Remote interface

Use the remote probe to start up or reset of test remotely

5、 Voltage rotary knob

In the test of DUT, rotate this knob to regulate the output voltage (turn knob clockwise: voltage rising, while counterclockwise: voltage falling)

Confirm the rotary knob is at the position of "0" before power is on.

6、 Loop terminal

It is the input terminal of measured current. During the test, the terminal leads should not be fallen off. If the test lead is fallen off, the DUT will be with high voltage and the electric shock maybe occurred.

7、 High voltage output terminal (H.V.)

Press „test“ key, the terminal can generate high voltage. Do not touch the high voltage port, high voltage leads, high voltage probe and DUT.

8、 Power supply safety detecting indicator light "O K"

Plug in, judge whether NLG are properly connected or not. The power switch is off, if the N、 L、 G is connected rightly, the "OK" indicator will light. If the N、 L、 G is wrongly connected, only "O" or "K" or neither of them is lighted. Please check the power supply. When power on, the indicator lights out.

9、 High voltage output indicator

The indicator is not controlled by the main circuit. If the output voltage is more than 50V, the indicator will light up. If it is lighted on the reset status, the H.V. terminal maybe existed high voltage, please do not touch any part of the circuit. When the tester outputs high voltage, the indicator lights up all the time, which indicates it is dangerous during high voltage outputting.

10、 Fail indicator

When the test is failed, the indicator will light.

11、 Test indicator

When the start key is pressed, the indicator will light.

12、 Voltage display

13、 Current display

14、 Time display

Time is range from 0.0s to 999s. When the test time is less than 100s, the resolution is 0.1s; while the time is greater than or equal to 100s, the resolution is 1s. If the time is set to 0.0s, the test time will add counts; when the time is not set to 0, the time will be down counting.

15、 UP key

When do the test time set, press the up key, the test time set will be up.

16、 DOWN key

When do the test time set, press the down key, the test time set will be down.

17、 Current preset adjustment potentiometer

After pressing the numbered (18) button "test / Pre-set", the tester will enter into the current preset state, the current display will show the preset current value, clockwise to increase the preset current; counterclockwise to decrease the preset current.

18、 2mA/20mA switch gear

Press the key is for 20mA gear, pop-up for 2mA gear.

19、 Test /pre-set key

This key is pressed for the pre-set current state, while pop-up for test status.

20、 100mA switch gear

Press the key is for 100mA gear, pop-up for 2mA/20mA gear.

21、 5kV/10kV switch gear

Press the key is for 10kV gear, pop-up for 5kV gear.

⑩CS2674AX front panel outline

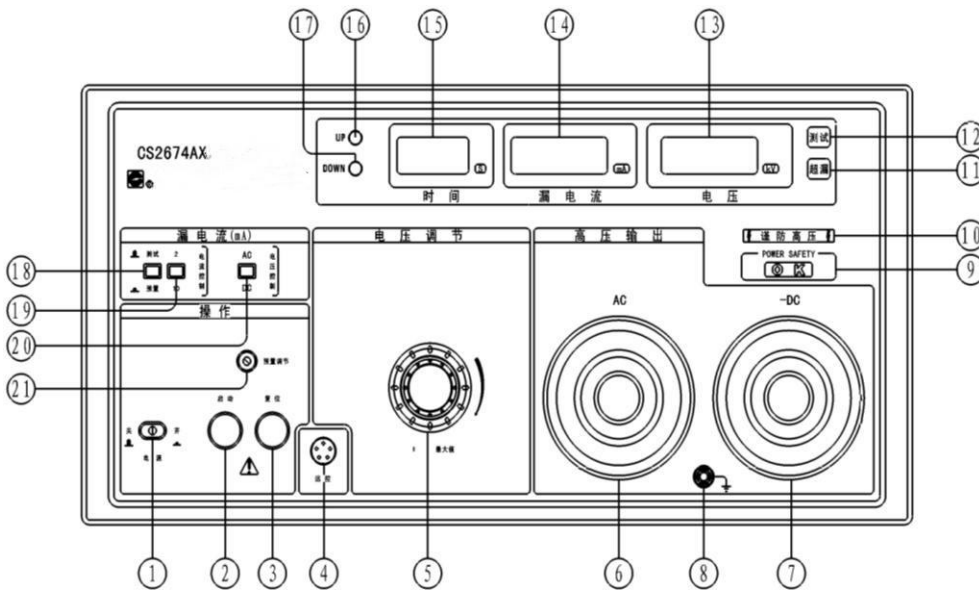

1、 Power switch

When the power switch is pressed, the tester is on, while pop-up it, the tester is off;

2、 START key

In the reset status, press this key, the tester starts to perform test

3、 STOP key

During the testing, it is used to interrupt the test. When DUT test failed, the failed indicator (10) is on, and at this time press the STOP key, the tester will stop alarming and enter into the next waiting test.

4、 Remote interface

Use the remote probe to start up or reset of test remotely.

5、 Voltage rotary knob

In the test of DUT, rotate this knob to regulate the output voltage (turn knob clockwise: voltage rising, while counterclockwise: voltage falling)

Confirm the rotary knob is at the position of “0” before power is on.

6、 Loop terminal

It is the input terminal of measured current. During the test, the terminal leads should not be fallen off. If the test lead is fallen off, the DUT will be with high voltage and the electric shock maybe occurred.

7、 DC High voltage output terminal (H.V.)

Press „test“ key, the terminal can generate DC high voltage. Do not touch the high voltage port, high voltage leads, high voltage probe and DUT. After the test is finished, make sure that all the electricity on the entire circuit has been discharged before change another DUT.

8、 AC High voltage output terminal (H.V.)

Press „test“ key, the terminal can generate AC high voltage. Do not touch the high voltage port, high voltage leads, high voltage probe and DUT.

9、 Power supply safety detecting indicator light “O K”

Plug in, judge whether NLG are properly connected or not. The power switch is off, if the N、 L、 G is connected rightly, the “OK” indicator will light. If the N、 L、 G is wrongly connected, only “O” or “K” or neither of them is lighted. Please check the power supply. When power on, the indicator lights out.

10、 High voltage output indication

The indicator is not controlled by the main circuit. If the output voltage is more than 50V, the indicator will light up. If it is lighted on the reset status, the H.V. terminal maybe existed high voltage, please do not touch any part of the circuit. When the tester outputs high voltage, the indicator lights up all the time, which indicates it is dangerous during high voltage outputting.

11、 Fail indicator

When the test is failed, the indicator will light.

12、 Test indicator

When the start key is pressed, the indicator will light.

13、 Voltage display

14、 Current display 15、 Time display

Time is range from 0.0s to 999s. When the test time is less than 100s, the resolution is 0.1s; while the time is greater than or equal to 100s, the resolution is 1s. If the time is set to 0.0s, the test time will add counts; when the time is not set to 0, the time will be down

counting.

16、UP key

When do the test time set, press the up key, the test time set will be up.

17、DOWN key

When do the test time set, press the down key, the test time set will be down.

18、Test /pre-set key

This key is pressed for the pre-set current state, while pop-up for test status.

19、2mA/20mA switch gear

Press the key is for 20mA gear, pop-up for 2mA gear.

20、AC/DC switch key

Press the key is for DCW test, pop-up for ACW test.

21、Current preset adjustment potentiometer

After pressing the numbered (18) button "test / Pre-set", the tester will enter into the current preset state, the current display will show the preset current value, clockwise to increase the preset current; counterclockwise to decrease the preset current.

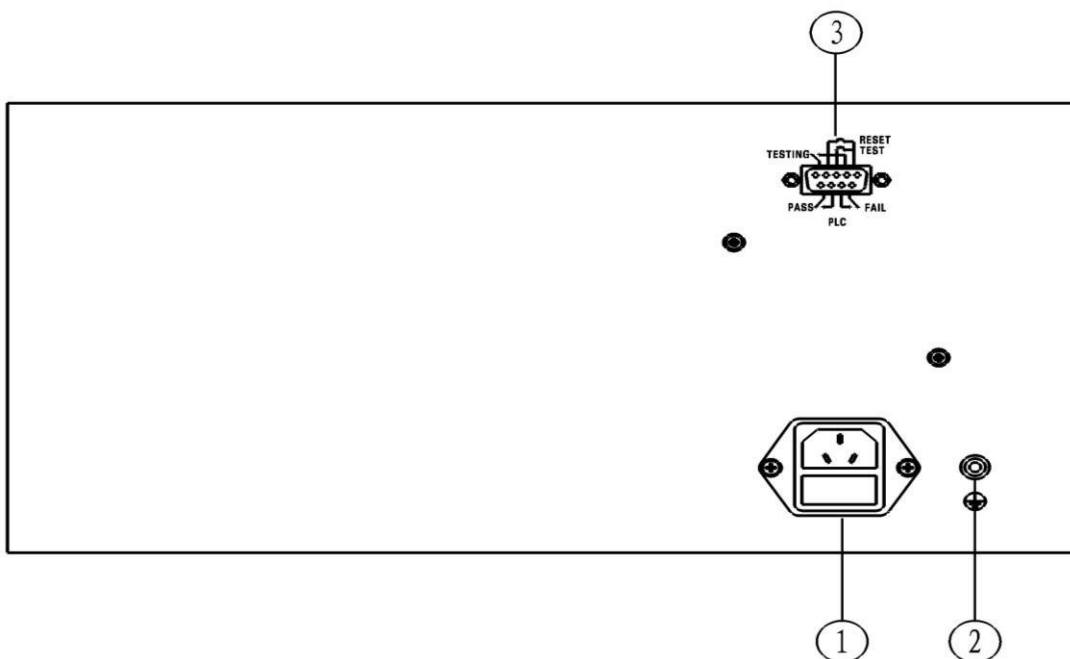

⑪Rear panel

1、Input power supply socket

Three core two-phase power socket. There is fuse in the power socket.

2、Protective earth

The protected earth terminal needs to be reliably connected to the protective ground.

Otherwise, the case of the tester may be filled with high-voltage and cause the electrical

shock.

3、PLC interface

Read the details on chapter 6;

⑫CS2670Y Rear panel

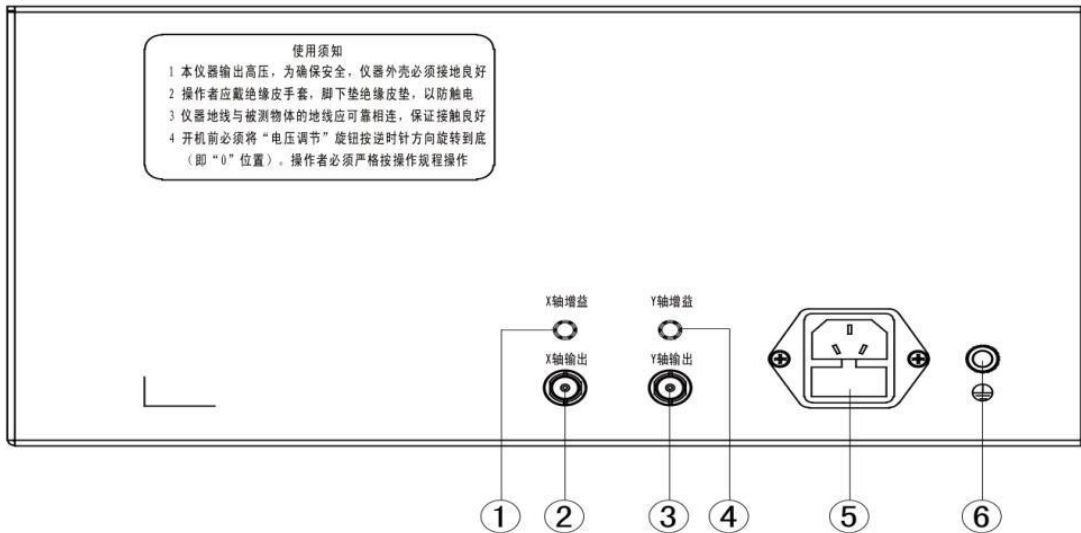

1、 X axis gain adjustment potentiometer

2、 X axis output interface

3、 Y axis output interface

4、 Y axis gain adjustment potentiometer

5、 Input power outlet

Three core two phase power socket. The power outlet is equipped with a fuse; the selection of the input voltage and the replacement of the fuse is referred to 1.7.

6、 Protective grounding end

This protection is to be reliably grounded on the ground. Otherwise, the test apparatus of the case may be full of high pressure, resulting in electric shock accident.

VI.PLC interface

There is remote control connection terminal on the back plate of the tester. This terminal can connect to remote manipulator to operate. It is a standard 9PIN D type terminal, with the following signals: connection test signals, reset signal, signal under testing, test pass signal, test fail signal.

1.Input signal & Output signal of PLC

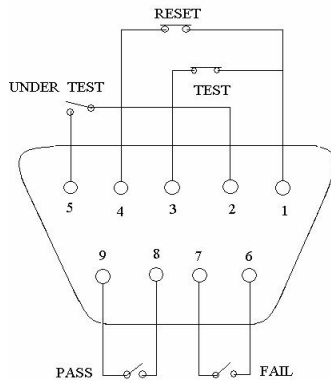

2.Connection

TEST control: The control switch is connected between PIN 1 and PIN 3. RESET control: The control switch is connected between PIN 1 and PIN 4. Signal output under testing: Between PIN 2 and PIN 5.

Test fail signal: Between PIN 6 and PIN 7. Test pass signal: Between PIN 8 and PIN 9.

3.Explain the Input & Output Signal Connection

This tester equips with remote control joints, and the TEST and RESET function of this instrument can be manipulated by the outside remote control device. These joints provide the power supply that holds control function, and thus the “Momentary Contact” switch must be used to act as the controller. Important: These joints must be prohibited to connect to any other power supplies. If they connect to other power supply, the inside circuit of this instrument may be damaged.

The output signal provides contact of a relay.

4.Electrical Performance of Interface

Output contact voltage: 24 V AC/DC Max. Current: 100mA

Terminal voltage when the input terminal connects to non-voltage control contact and has null connection: <10 V DC

VII.Operation Instructions and Procedures

Operation Procedures:

In the case of close and reset, the measured object is connected when the indicator of the

voltmeter is ensured to “0” and the indicator light for testing is switched off, and its grounding line is inserted under the earth;

1.The required testing value of leakage current is set:

- (1) Press the Preset switch;
- (2) Choose the range of the required alarm current;
- (3) Adjust the preset potentiometer for leakage current to the required alarm value;
- (4) Reset the preset switch;

2.Test Manual:

(1) The timing switch is set to the “OFF” position, the button “start” is pressed, and the “Test” indicator lights. The knob “Voltage Adjustor” is screwed to the required indicator value;

(2) After the testing finished, the voltage is adjusted to the 1/2 position of the testing value and then the button “Reset” is pressed. The voltage output is shut off and the indicator light is switched off. It proves that the measured object is good;

(3) If the current passing the measured object is greater than the specified leakage current, the instrument cut off the output voltage automatically, and simultaneously the buzzer gives out a alarm with sound and light, the overrun indicator light is activated. Here, the measured object is not eligible. The button “Reset” is pressed and then the alarm can be cancelled;

3.Timing Test

①While the “Timing” switch is “ON”, the time preset catch plate is dialed to set the required value of dwell time;

②The button “start” is pressed and the voltage is adjusted to the required testing value;

③When the timing is over, the testing voltage is shut off. It proved that the measured is good; if the current is greater, prior to the preset time, the overrun indicator light is activated and the buzzer gives out a alarm, and thus the measured object is bad.

4.DCWTest(CS2671AX,CS2671BX,CS2672CX,CS2672DX,CS267

4AX)

- (1) The voltage change-over switch is pressed, and the DC step is set;
- (2) The high voltage line of the measured object connects to the high voltage DC output terminal;
- (3) Continue to operate according to the above the required testing value of leakage current set 3 and 4;
- (4) Caution: voltage of the high voltage DC output terminal is negative voltage;
- (5) The setting range of the leakage current alarm value is from 0.3 mA to 20 mA. When the leakage current is above 20 mA, the current automatic protection and alarm are activated.

5.Remote Control Test: (Note: When a remote control test probe is applied, the time is controlled manually.)

Example: The timing time is set to 11 s, and the remote control test gun is used to test the measured object. The test gun is activated till the time is over, and then the test gun will restart.

- (1) The remote control testing accessories connects to the instrument, and the testing voltage (AC/DC) is selected;
- (2) The required value of testing voltage is set;
- (3) The required value of leakage current testing is set;
- (4) The remote control test gun connects to the measured object;
- (5) The switch "Start" on the high voltage gun is pressed to test, and while the test finish, the switch is released.

6.Pre-set the test time

- (1) Preset conditions

The tester must be in the reset state, the tester can not be in the test status or the alarm status.

- (2) Preset methods

- ① Increase

Press the UP button on the front panel, the time preset value will plus 1; Press the up button continuously and hold the button, the time preset value will increase 1 continuously. If a certain value is added to, the time preset value will increase 10 until up to 999s.

②Decrease

Press the DOWN button on the front panel, the time preset value will minus 1; Press the down button continuously and hold the button, the time preset value will minus 1 continuously. If a certain value is decreased to, the time preset value will decrease 10 until up to 0.0s.

7.Preset the ACW leak current alarm value

(1) Preset conditions

Pop-up the AC / DC switch button in the front panel to make the tester be on the ACW test status. Note: If the tester is single ACW test, this step can be ignored.

(2) Preset methods

Press the test / preset buttons, the LED window show the current pre-set value. Adjust the potentiometer clockwise, the current pre-set value will be increased. Counterclockwise adjustment will reduce the pre-set leak current. If the preset current is up to the desired value, pop-up the test / preset button.

8.Preset the DCW leak current alarm value (Single ACW tester is without DCW test)

(1) Preset conditions

Press the AC / DC switch button in the front panel to make the tester be on the DCW test status.

(2) Preset methods

Press the test / preset buttons, the LED window show the current pre-set value. Adjust the potentiometer clockwise, the current pre-set value will be increased. Counterclockwise adjustment will reduce the pre-set leak current. If the preset current is up to the desired value, pop-up the test / preset button.

(3) Adjust the output voltage

When the voltage regulator knob is at the position of 0, there is no high voltage output even if starts the tester. Press the start button and adjust the output voltage knob clockwise slowly until the output voltage reaches to the required voltage

VIII.Applying Illustration

1.Preparation of test

①Avoid electric shock

Please wear insulated gloves and stand on the insulation pad when operate the hipot tester. Note: the withstanding voltage of insulating gloves and insulated pad should be twice than the maximum output voltage of the tester.

②Set the alarm value of leak current and test time

Please refer to the seventh chapter.

③Connect the DUT(Device Under Test) to the tester

Please confirm the following before connection:

- 1, The tester is shut down or on the reset status;
- 2, The high voltage indicator is not light;
- 3, The voltage window show 0;

Connect the current measurement loop terminal firstly then connect DUT to the high voltage terminal.

2.Test mode

①Manual test

If the test time is set to 0, the tester will not judge the test time during testing. The tester is in a continuous test condition in the test.

After the "START" button is pressed, the test light will be lit; adjust the output voltage knob at a desired value, the tester will do the test continuously. During the test, if the test current is great than the preset value, the tester will alarm with sound and light. Press the "STOP" key, the alarm will be stopped. Replace the DUT and continue to test. After testing, press the "STOP" key to stop the test.

②Automatic test

If the test time is not set to 0, the tester will enter into the automatic test. After the "START" button is pressed, the test light will be lit; adjust the output voltage knob at a desired value,

the tester will do the test. During the test, if the test current is great than the preset value, the tester will alarm with sound and light. Press the "STOP" key, the alarm will be stopped. If the test time is return to 0 and the tester is not alarm, the test is passed and the DUT (Device Under Test)T is eligible.

Note: During DCW test, confirm the measurement circuit is without any electricity before replace another device.

3.Electrical machine- whole instrument"s electric intensity (Withstanding voltage intensity) test

According to the picture below to connect the Withstanding voltage tester and DUT, get through the power supply switch, set the leakage current warning value according to the product standard of DUT, and then test it as per the 3 or 4th operation steps. If there is no concrete leakage current warning value in the product standard, following formula is recommended:

$$I_z = k_p(U/R), \dots, (1)$$

I_z —Leakage current warning value A;

U —Test voltage, V;

R —Allowed minimum Insulation resistance value ;

k_p —Motion index, generally take 1.2~1.5

For instance: One electrical machine with its regulated min. IR value as 2×10^6 , test voltage is 1500V。

As per formula (1), then

$$I_z = k_p(U/R) = (1.2 \sim 1.5) (1500 / 2 \times 10^6) \\ = (1.2 \sim 1.5) 0.75 \times 10^{-3} = 1 \times 10^{-3} (A)$$

Take 1mA.

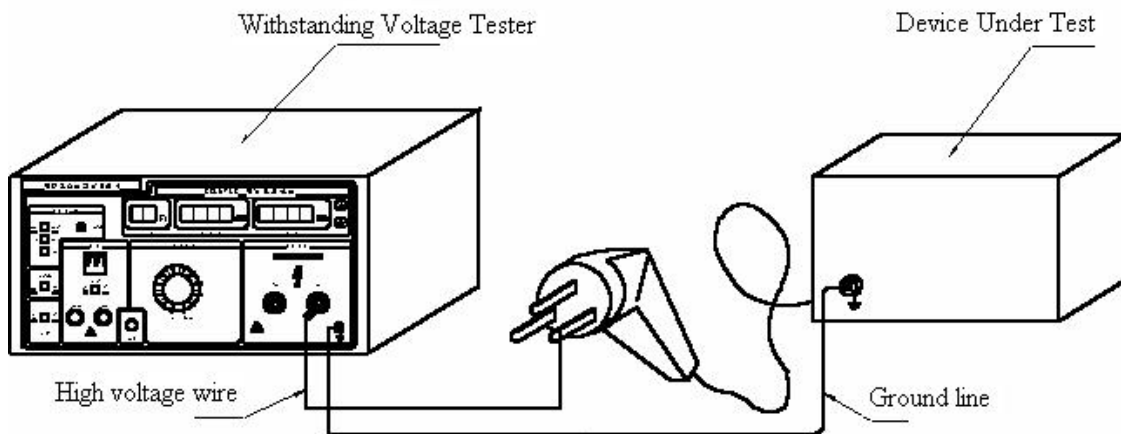

4. Transformer or electrical instrument's electric intensity (Withstanding voltage intensity) test

According to the picture below to connect the Withstanding voltage tester with DUT, set the leakage current warning value according to the product standard of DUT, and then test it as per the 4 or 5th operation steps. If there is no concrete leakage current warning value in the product standard, please calculate as formula (1) above and then set the value:

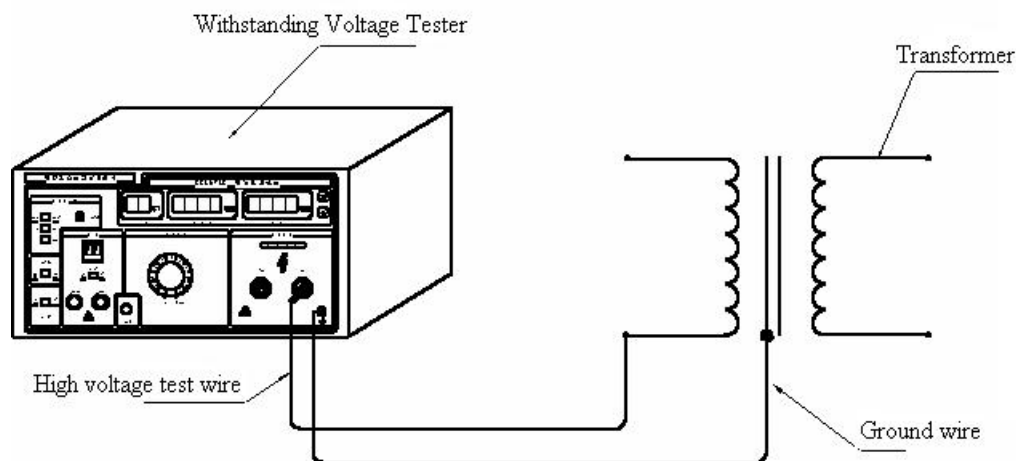

5. Capacitor's electric intensity (Withstanding voltage intensity) test

According to the picture below to connect the Withstanding voltage tester with tested capacitor, if making DC test, in order to avoid wrong alert user shall add voltage slowly and make the charge current less than the warning value of leakage current; if making AC

test, the capacitor current caused by tested capacitor's capacitive reactance (X_C) shall be added while set leakage current warning value, otherwise the wrong alert will happen.

After test, please remember to discharge the two terminals of capacitor to avoid electric shock!

(a) Judgment of high voltage silicon stack and high-voltage power transistor's BV_{CEO} .

According to the picture below to connect the Withstanding voltage tester with the tested high-voltage silicon stack or high-voltage power transistor, pay attention to the DC high-voltage output terminal of the Tester is negative polarity ($-$), ground wire is positive polarity ($+$), and set the leakage current alert value to 0.2mA, add voltage slowly to the rated value while starting it. If it alerts or the leakage currents augmented, then the tested high-voltage silicon stack and high-voltage power transistor has been damaged, contrariwise it is normal.

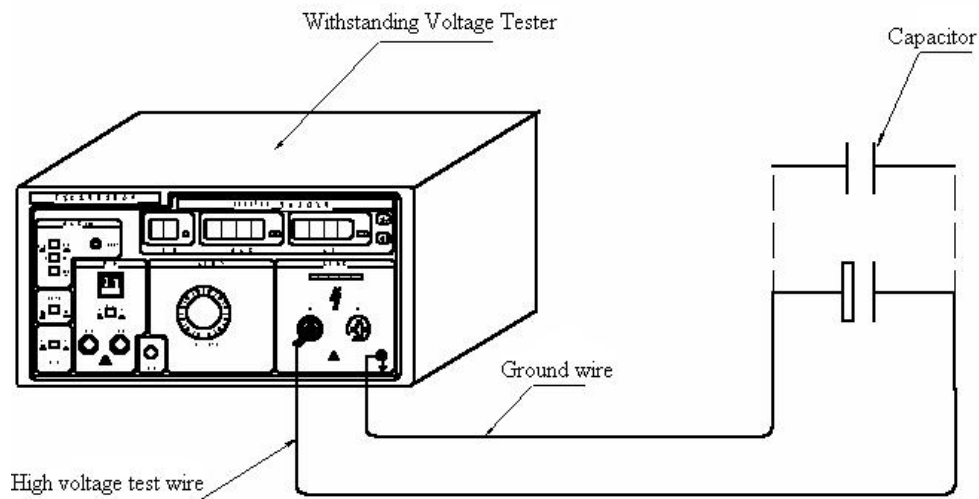

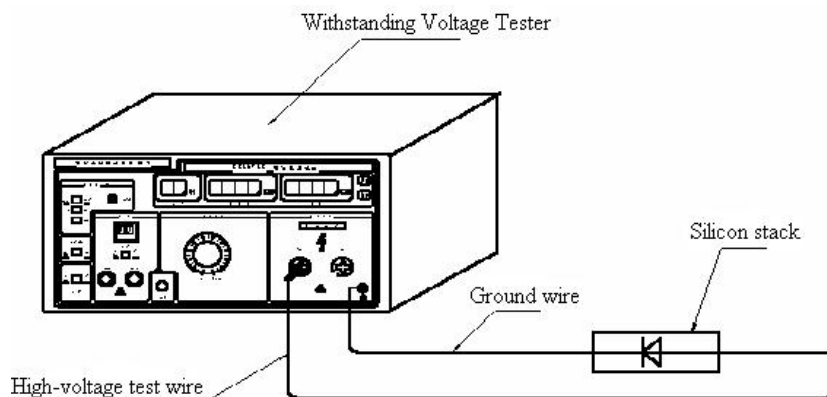

IX. Calibration

1. Calibration

(1) Voltage calibration

- ① Instrument states in Reset, and voltage knob is rotated to the end in anti-clockwise;
- ② Connected the voltmeter with the instrument well according to the picture and table below;
- ③ Choose the proper measurement range on the voltmeter according to different model of the instrument. Please notice that the error of the voltmeter shall be within 1.5%, if it is a hand-style voltmeter, the measurement range shall be out of 1/3 in the graduation of staff gauge. The company produced CS149-10 Digital high voltage meter is recommended;
- ④ Press down Start, and calibrate the voltage output knob to make the readout numbers in voltmeter correspond with the detecting points in List 1 and then adjust the potentiometer to make the meter indication and high-voltage voltmeter's indication satisfy the technology requirement.

List 1

AC/DC	Voltage range	Potentiometer	Detecting points	Index
AC (kV)	5kV	W4	0.5; 1; 3; 5	3%
	10kV	W4	1; 3; 5; 10	
DC	5kV	W5	0.5; 1; 3; 5	

(kV)	10kV	W5	1; 3; 5; 10
------	------	----	-------------

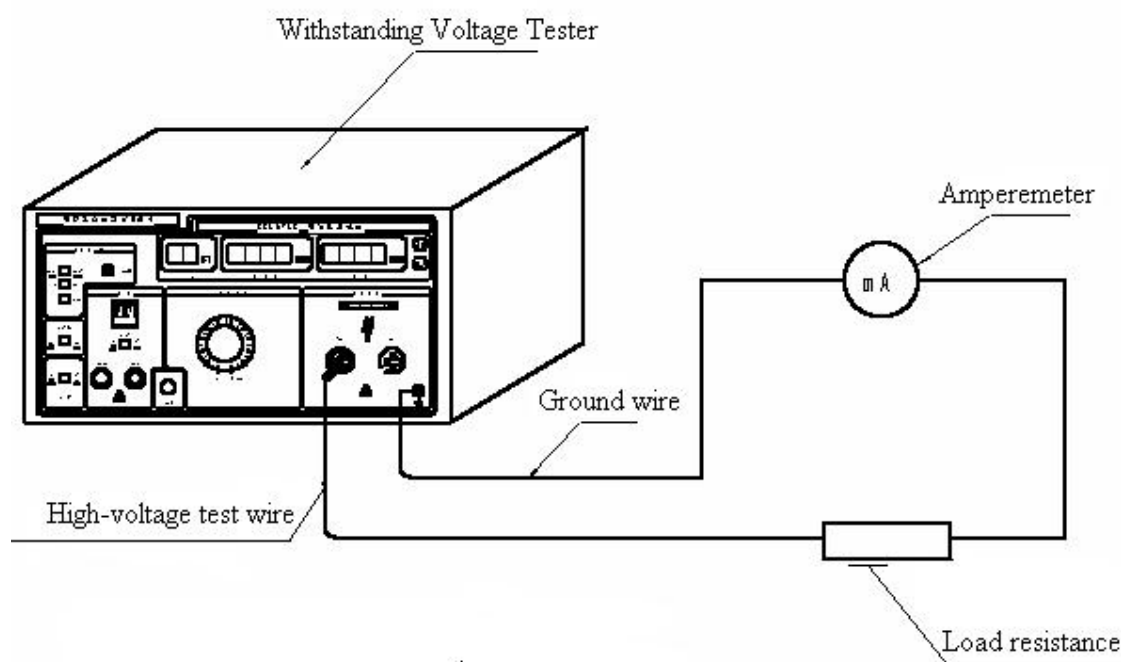
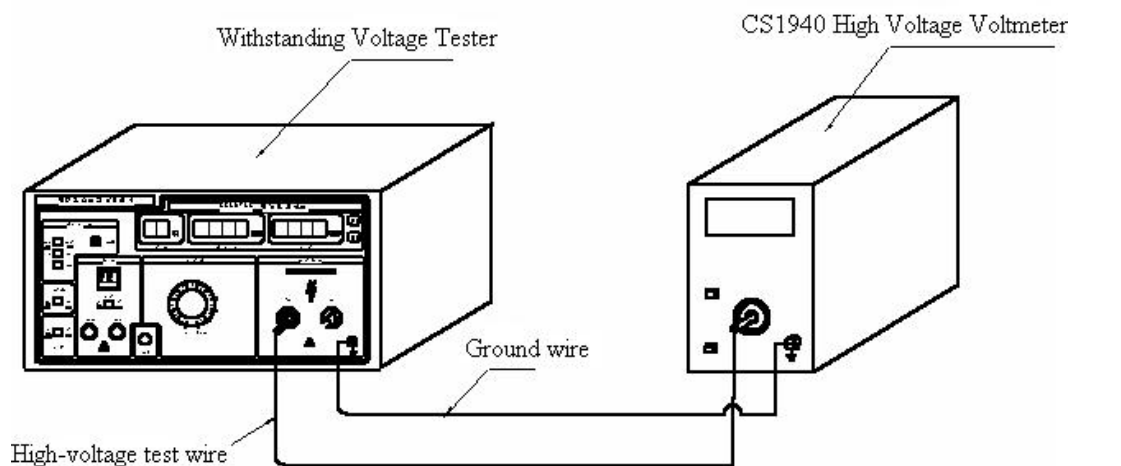

(3)DC leakage current calibration

Adjust the AC/DC selection switch to DC level, leakage current selection switch to 1mA, slowly adjust the voltage to make the digital amperemeter display (or CS2040

Withstanding Voltage Calibrator) synchronizes with that of the meter hand, if the display is not synchronized, calibrate W7 potentiometer to make it synchronized, and alert in full-graduation of 1mA.

①Maintenance

Maintenance of Withstanding Voltage Tester (Ref. to below list)

Maintenance Guidance of Withstanding Voltage Tester

Faults	Reasons	Measurements
(1)Power light cannot be bright when turned on, and no indication and output.	(1) Whether power supply is connected well?	Connect power supply well and test by multimeter, there maybe 220V.
	(2)Whether fuse is OK?	Change fuse
	(3)Whether power switch is OK?	Change power supply switch
	(4)Whether there is about 17V AC voltage at the output terminal of transformer, if no, the power transformer maybe broken.	Change power transformer
	(5)Whether rectifier diode is broken?	Change corresponding rectifier diode

	(6)Whether three-terminal Steady pressure machine 7812 is broken?	Change 7812
	(7)Whether C1~C4 capacitor is electric short	Change relevant capacitor
(2) Alert when open the instrument	(1)Keys of leakage current level flick	Press down any key
	(2)LM324 is broken.	Change 324
	(3)Sample resistor on Leakage current switch is open.	Change relevant resistor
(3)Start, Reset failure	(1)556 is damaged	Change 556
	(2)Relative Start or Reset key is broken.	Change the relevant switch
	(3)The linking jack is loose on main circuit board.	Secure the jack
	(4)Lead on main circuit board is open.	Weld the lead well
(4) State in test while turn on the machine	556 is damaged.	Change 556
(5) Timer fails in start when testing.	(1) Timer plug is loose.	Secure the plug
	(2)4060 is broken.	Change 4060
(6) Timer cannot reset when time is up. (Manual	(1) Timer plug is loose.	Secure it
	(2)Timer 9013 is broken.	Change 9013

operation is excluded.)	(3) Timer4060 is broken.	Change 4060
(7) When turn on the instrument, the test light is bright but no voltage display.	(1) Voltage in electric net is too low results in power voltage too low and power relay cannot work normally.	Use AC Steady pressure machine or voltage regulator
	(2) Power relay is broken.	Change relay
	(3) Voltage display board is broken.	Change it.
	(4)High-voltage output terminal is disconnected.	Welded it well
	(5)High-voltage transformer is broken.	Change the high-voltage transformer.
	(6)Plug or connecting wire of main circuit board is loose.	Secure the plug and connect it well.
(8) Manual start or reset is failed.	(1) No12V voltage	Check power section
	(2)556 is broken.	Change 556
(9) Start and Reset are failed in operation.	Start or Reset key is bad connection or damaged.	Change relevant switch
(10) AC/DC output voltage cannot be adjusted and the transformer works with noise.	(1) Capacitor box is broken (D6、C6、R3 and R4 are equipped in one plastic box.)	Change capacitor
	(2)High-voltage transformer is broken(there are striking fire and have electric short phenomenon)	Change high-voltage transformer
(11) No voltage indication when adjusting voltage.	(1) Voltage regulator is broken.	Change voltage regulator.
	(2)Linking plug of main circuit board may have bad connection or open phenomena.	Secure the plug and connect it well.
	(3) D8~D11diodes have some broken or weak welding.	Change relevant diode
(12) Indicating value and actual value have large error (half).	(1)D12~D15 diodes have some broken.	Change relevant diode
	(2) Leakage current displaying board is broken.	Change current displaying board.
	(3)C7 and R11 Pressure sensitive resistor are weak welded.	Weld it well
(13) No voltage display	(1)220 /5W resistor is open or weakly welded	Weld the component well.
	(2) Leakage current displaying board is broken.	Change current displaying board.
	(3) 324 is broken.	Change 324.

	(4) Pressure sensitive resistor has electric shock.	Change pressure sensitive resistor
--	---	------------------------------------

X.Maintenance

1.Maintenance period: The instrument is warranted to be free from use for a period of 12 months from the date of shipment to the original end users in different sales spots.

2.Maintenance : Please bring forth the warranty card while maintaining. The company provides lift-long maintenance service to all the shipped instruments.

3.In this period, consumer is responsible for the maintaining fee if the instrument is damaged by improper operation.

The copyrights reserved by Allwin Instrument Corporation

The products of Allwin appreciate the protection of approved and examining Chinese potent. The information of the Operation Manual replaces all the data and files published before. The company holds the rights to change the specification and price; no additional notice will be available.

XI.Packing List

No.	Item	Qty
1	Power Line	1
2	Programmable High Voltage Test Clamp	1
3	Withstand Voltage Test Rod	1
4	Ground line	1
5	U Disk	1